

Outdoor supporting insulator 20 ANO - 3

Product order code: 600 000 003

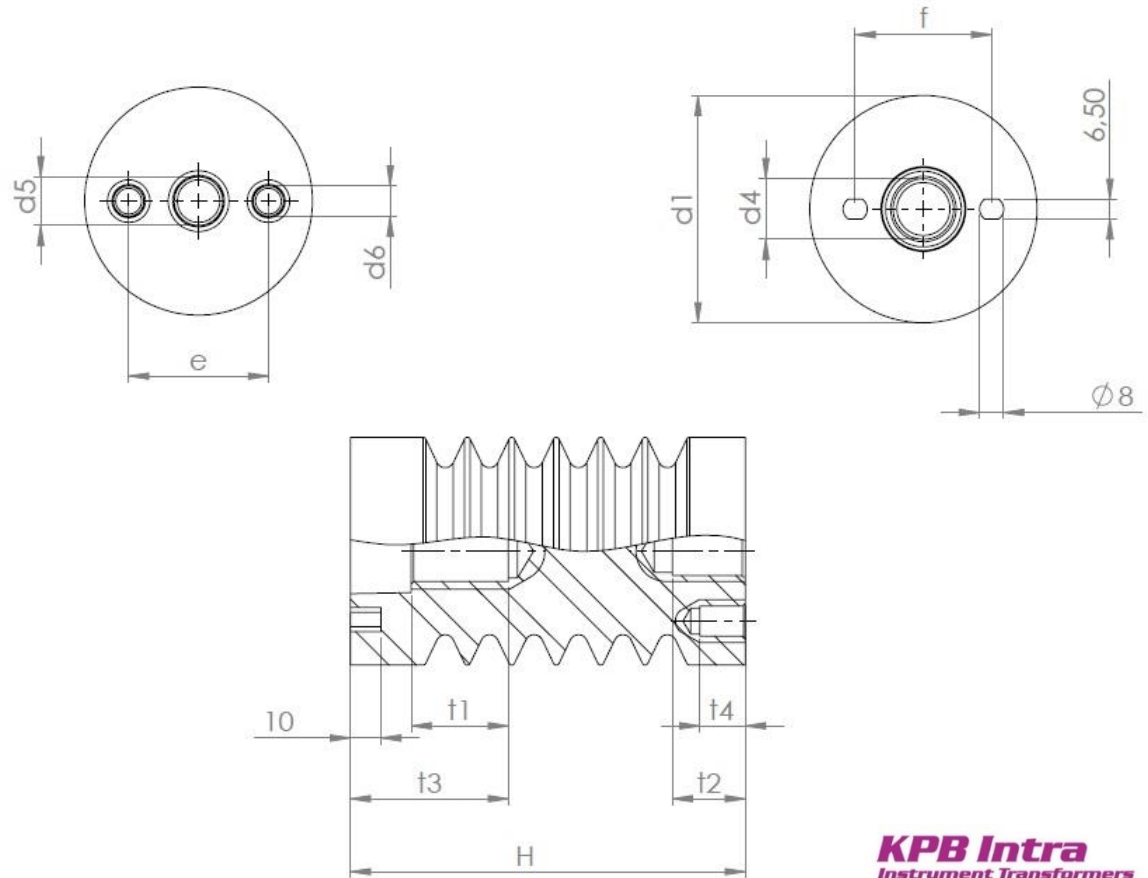

KPB Intra
Instrument Transformers

Type of outdoor supporting insulator	Highest voltage for equipment [kV]	Power frequency test voltage [kV]	Lightning impulse test voltage [kV]	Failing load [N]	Height [mm]	d1	d4	d5	d6	e	t1	t2	t3	t4	f	Creepage length [mm]	Weight [kg]
20 ANO - 3	24	50	125	5000	280	126	M16	M10	M6	36	33	17	53.5	13	0	625	2.4

