

Outdoor supporting insulator 30 ANO - 2

Product order code: 600 000 006

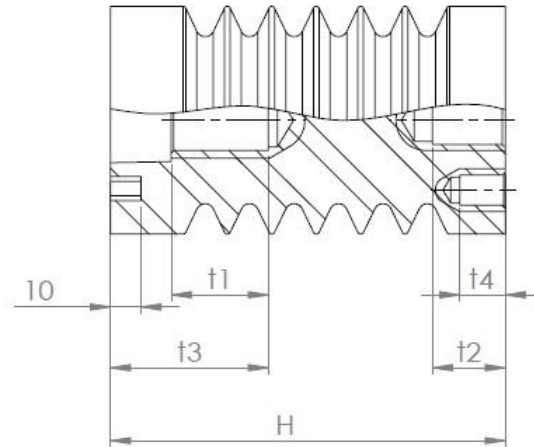
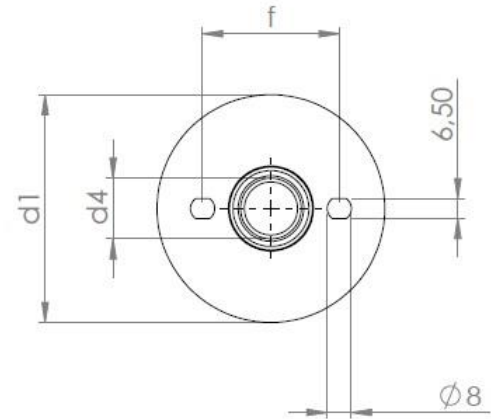
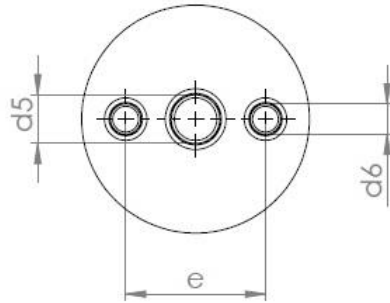

KPB Intra
Instrument Transformers

Type of outdoor supporting insulator	Highest voltage for equipment [kV]	Power frequency test voltage [kV]	Lightning impulse test voltage [kV]	Failing load [N]	Height [mm]	d1	d4	d5	d6	e	t1	t2	t3	t4	f	Creepage length [mm]	Weight [kg]
30 ANO - 2	36	70	170	5000	360	130	M16	0	M6	36	33	0	53.5	13	0	824	3.3

